

Introduction to Biogeography

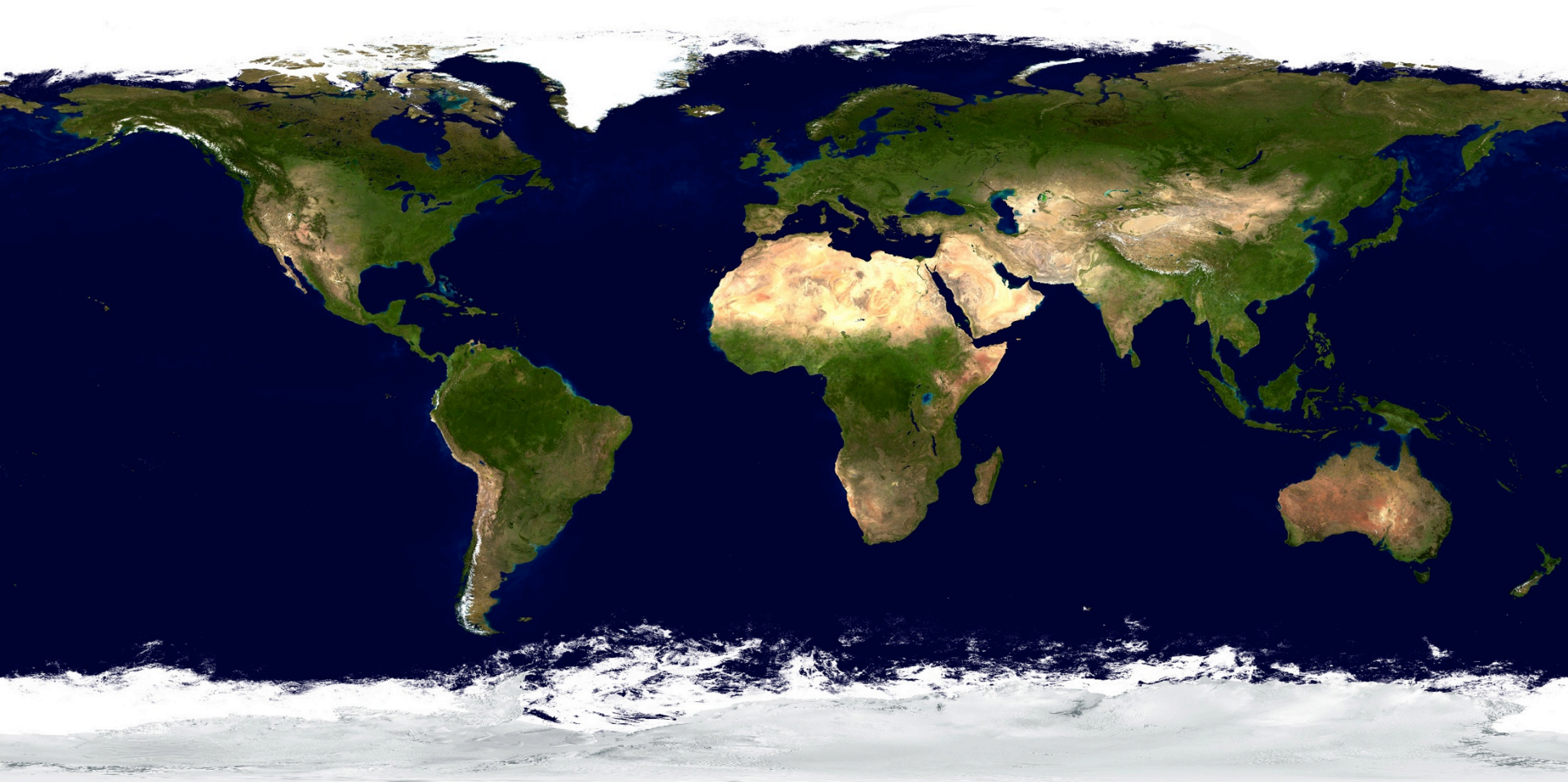

Image credit: www.oera.net/How2/PlanetTexts/EarthMap_2500x1250.jpg

Introduction to Biogeography

Biogeography: The study of the patterns and processes that influence the distribution of species and their characteristics or traits (in the past, present and future). Biogeography also looks at patterns of diversity (e.g., why do we find more species in South America than in North America?)

Biogeography is a broad discipline but has two main branches

Ecological Biogeography: present distributions and geographic variation in diversity, how biotic and abiotic interactions influence species distributions

Historical Biogeography: reconstructing the origin, dispersal and extinction of species or taxonomic groups

Introduction to Biogeography

Two branches of biogeography

Ecological Biogeography

- contemporary processes
- recent past
- interactions between species (e.g., predation and competition)
- interactions with abiotic environment

Historical Biogeography

- speciation and extinction
- continental drift
- glaciation
- evolutionary lineages

Many questions use a combination of ecological and historical hypotheses

Introduction to Biogeography

Some common questions in biogeography:

Why do different regions of the globe that are physically and environmentally similar have different species?

What limits species distributions? What prevents species from colonizing other areas?

Where, when, and under what conditions have species originated?

Why are the tropics so biologically diverse relative to higher latitudes?

Avian Richness

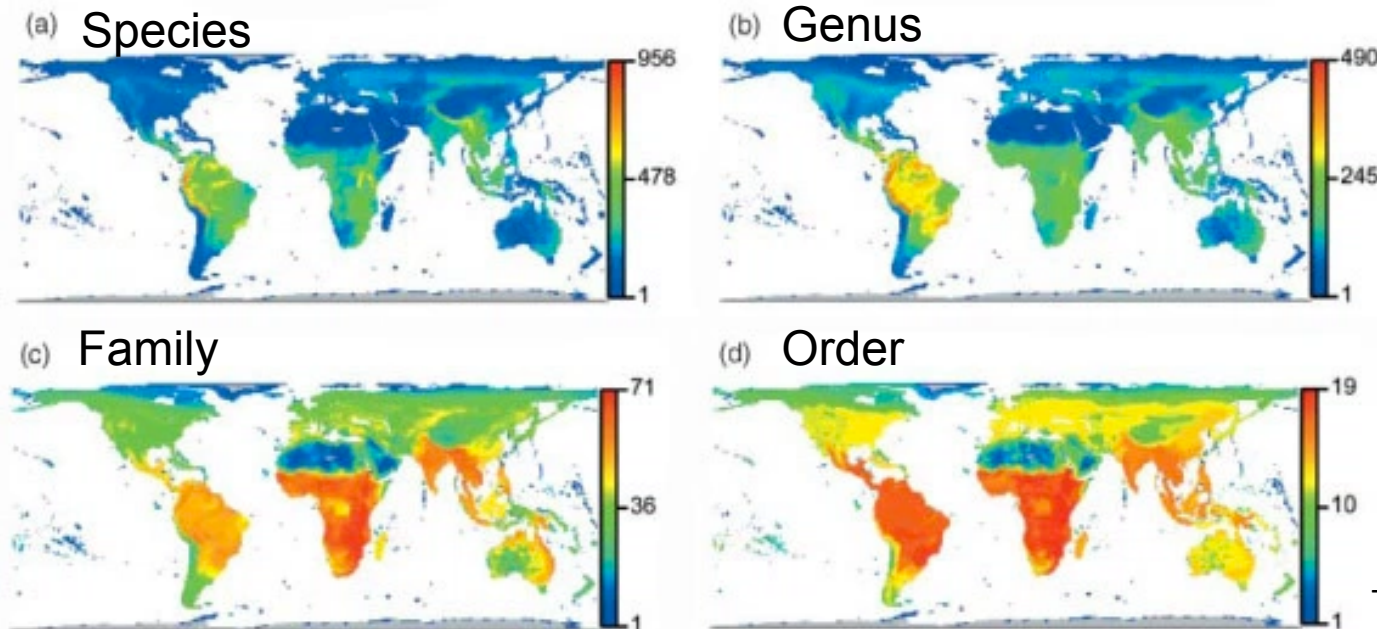

Case study: Green turtles on Ascension Island

How did Green turtles establish a colony on Ascension Island that is so isolated (about 2,500 km) from Brazil?



Green sea turtle (*Chelonia mydas*)

Green turtles are found in tropical oceans throughout the world. Female turtles return to nest on the beaches where they were born. Feeding grounds may be located thousands of kilometers from nesting beaches.

A nesting beach is located on Ascension Island on the mid-Atlantic ridge between South America and Africa.

Case study: Green turtles on Ascension Island



Image credit: www.pbs.org/odyssey/odyssey/20050530_log_transcript.html

Dispersal hypothesis:

They arrived relatively recently. Some females strayed from their natal beach, found Ascension Island, and established a nesting beach.

Vicariance hypothesis:

They arrived a long time ago. Ancestors of Ascension Island turtles nested on beaches of islands adjacent to S.A. coast throughout the late Cretaceous (135-65 mya). Over the last 70 my, these islands have been displaced by sea-floor spreading (2 cm/year).

Case study: Green turtles on Ascension Island



Dispersal and *vicariance* hypotheses are part of an age-old divide in biogeographic inference.

What predictions do the two hypotheses make, and what data can be collected to address them?

Case study: Green turtles on Ascension Island

mtDNA phylogeny

Turtles from Ascension island nesting colony are genetically identical to turtles from the Brazilian nesting colony.

Green turtles must have dispersed to Ascension Island from Brazil very recently (e.g., within the last 10,000 years)

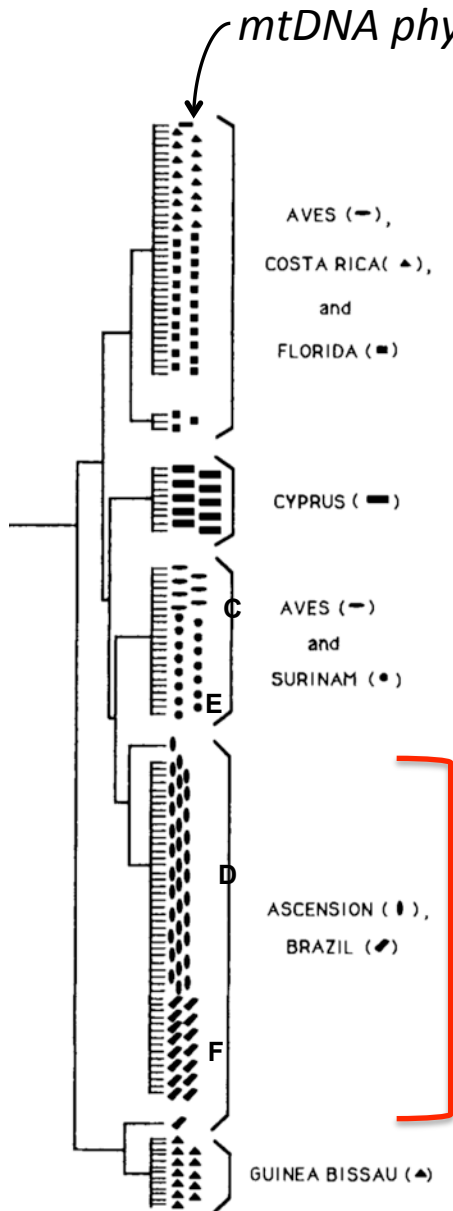

Case study: Green turtles on Ascension Island

Turtles from Ascension island nesting colony are genetically identical to turtles from the Brazilian nesting colony.

Could it be the same population?

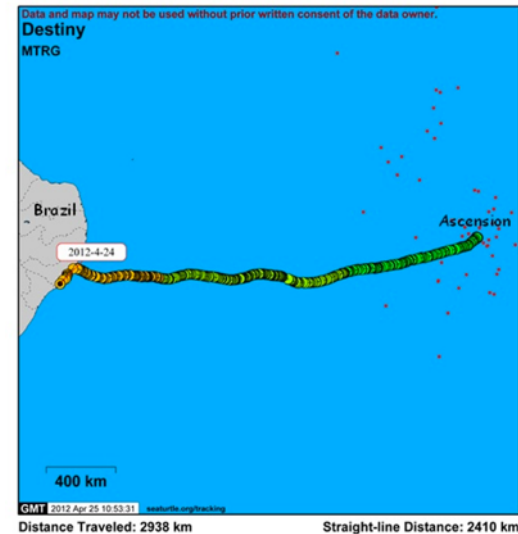

Satellite-telemetry tags have shown that green turtles nesting on Ascension Island migrate from feeding grounds off the coast of Brazil every 3 to 4 years to lay eggs – a 5 to 6 week journey!

Case study: Green turtles on Ascension Island

Turtles from Ascension island nesting colony are genetically identical to turtles from the Brazilian nesting colony.

Could it be the same population?

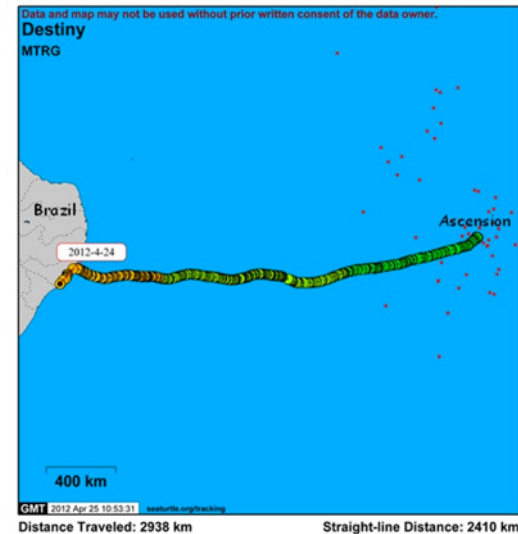

“Destiny” traveled 2938 km to reach Ascension Island!

Lots of websites on sea turtle research – here is one: <http://www.seaturtle.org/mtrg/>

Case study: Mammal and Bird Diversity in the Great Basin Mountains

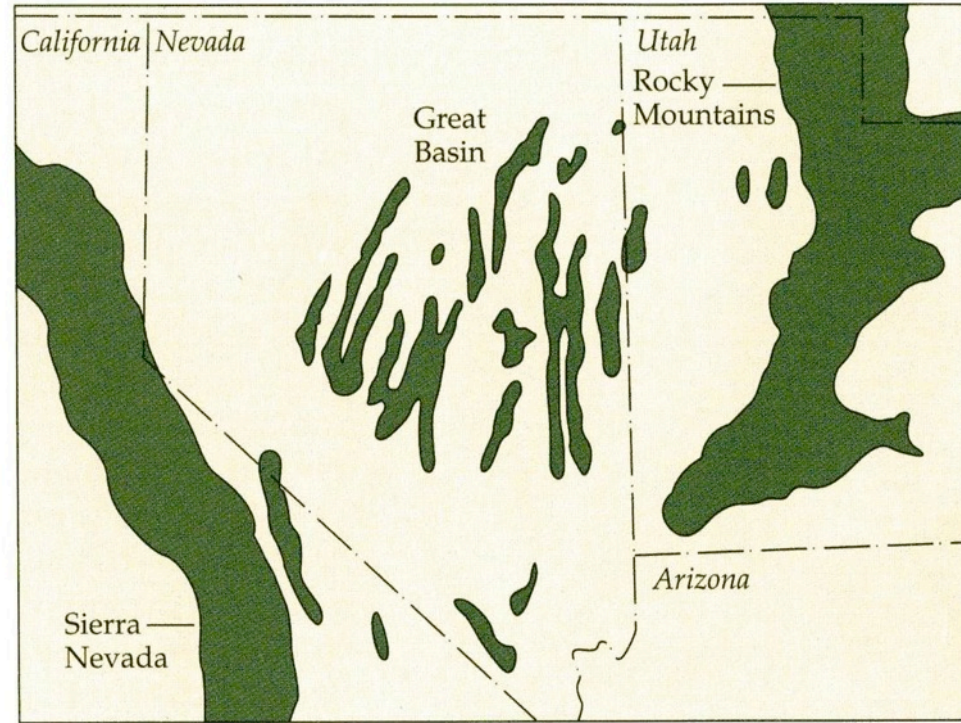
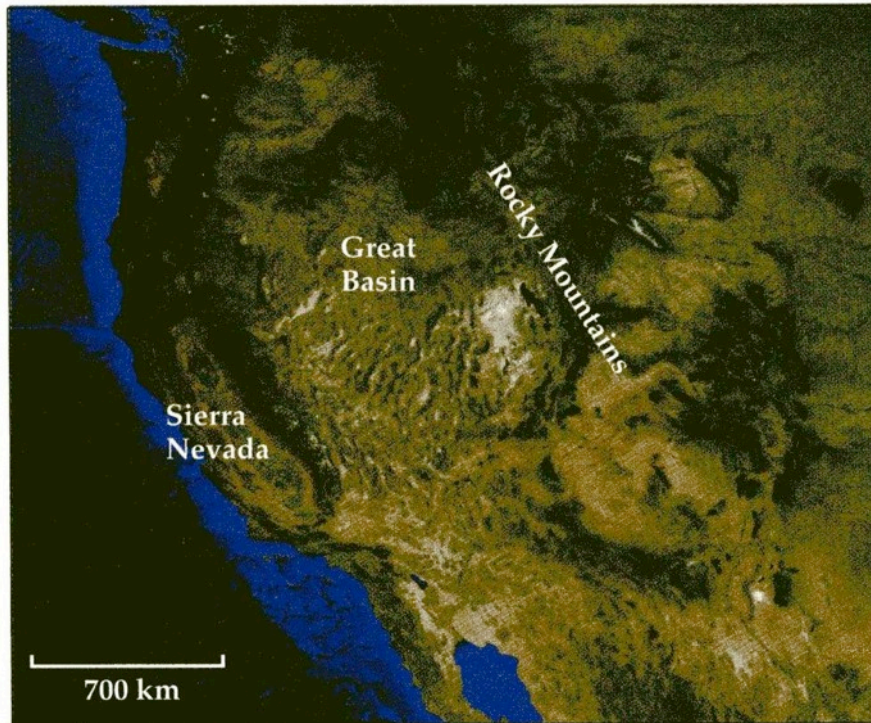

North American Great Basin. The image on the right shows areas of forest habitat higher than 2300 m elevation.

(Lomolino *et al.* 2010)

Case study: Mammal and Bird Diversity in the Great Basin Mountains

Several mammal and bird species are restricted to mountain forest habitats



Case study: Mammal and Bird Diversity in the Great Basin Mountains

How does species richness change with area of forest habitat?

Why are there more species on larger “islands” of forest habitat?

Species-area relationship: $S = c A^z$ where S = number of species, A is habitat area and z is the slope of the species - area relationship (log - log space).

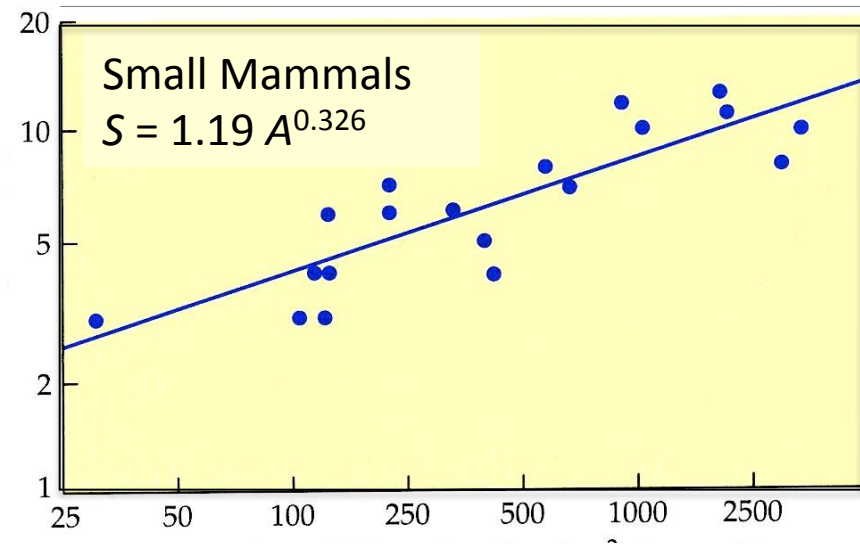
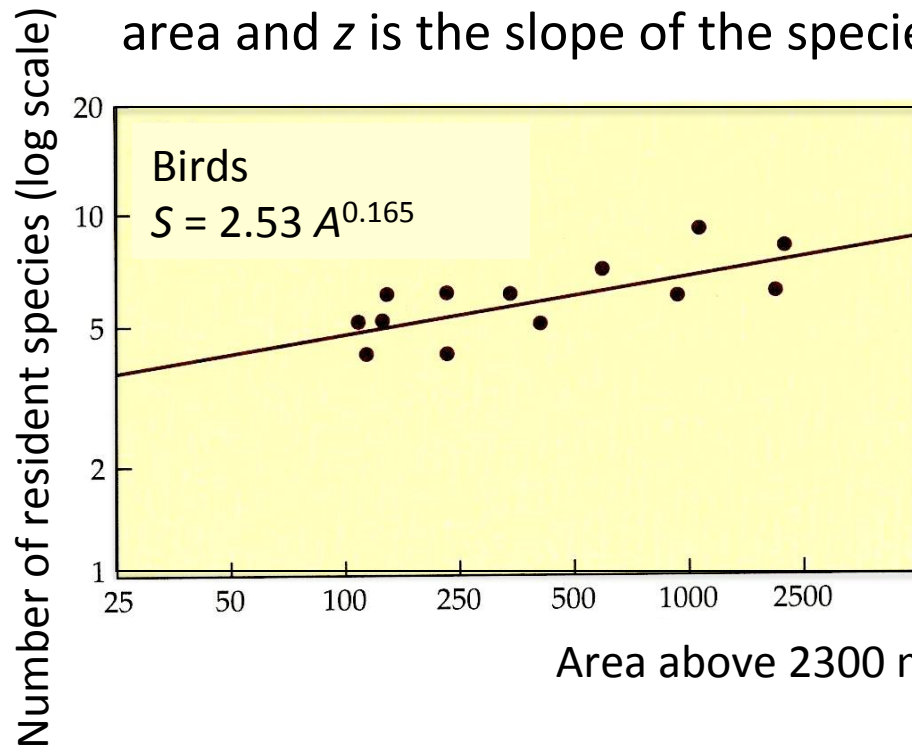

Area above 2300 m elevation (km²) (log scale)

Predicting current and future bird species distributions along elevational gradients



The study of species borders is a unifying theme in ecology

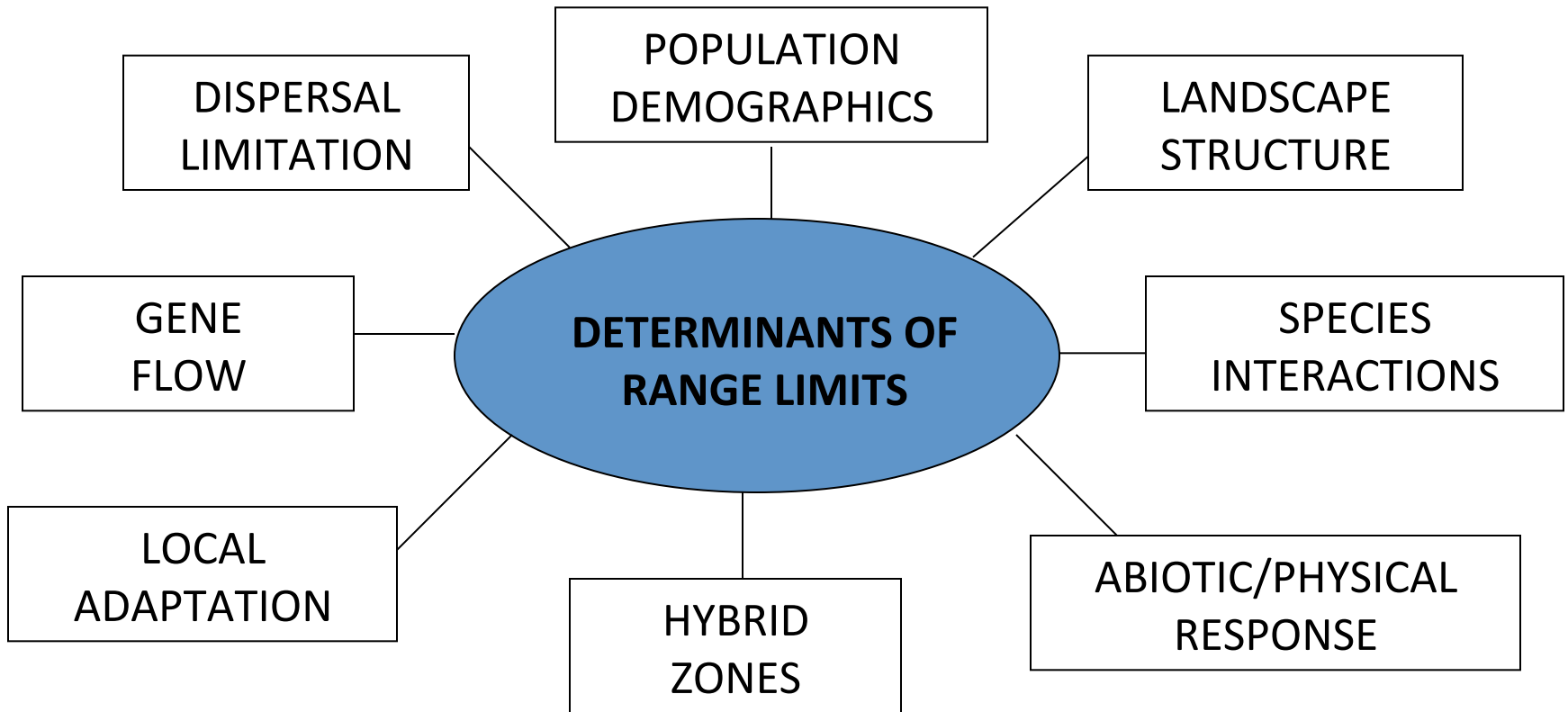

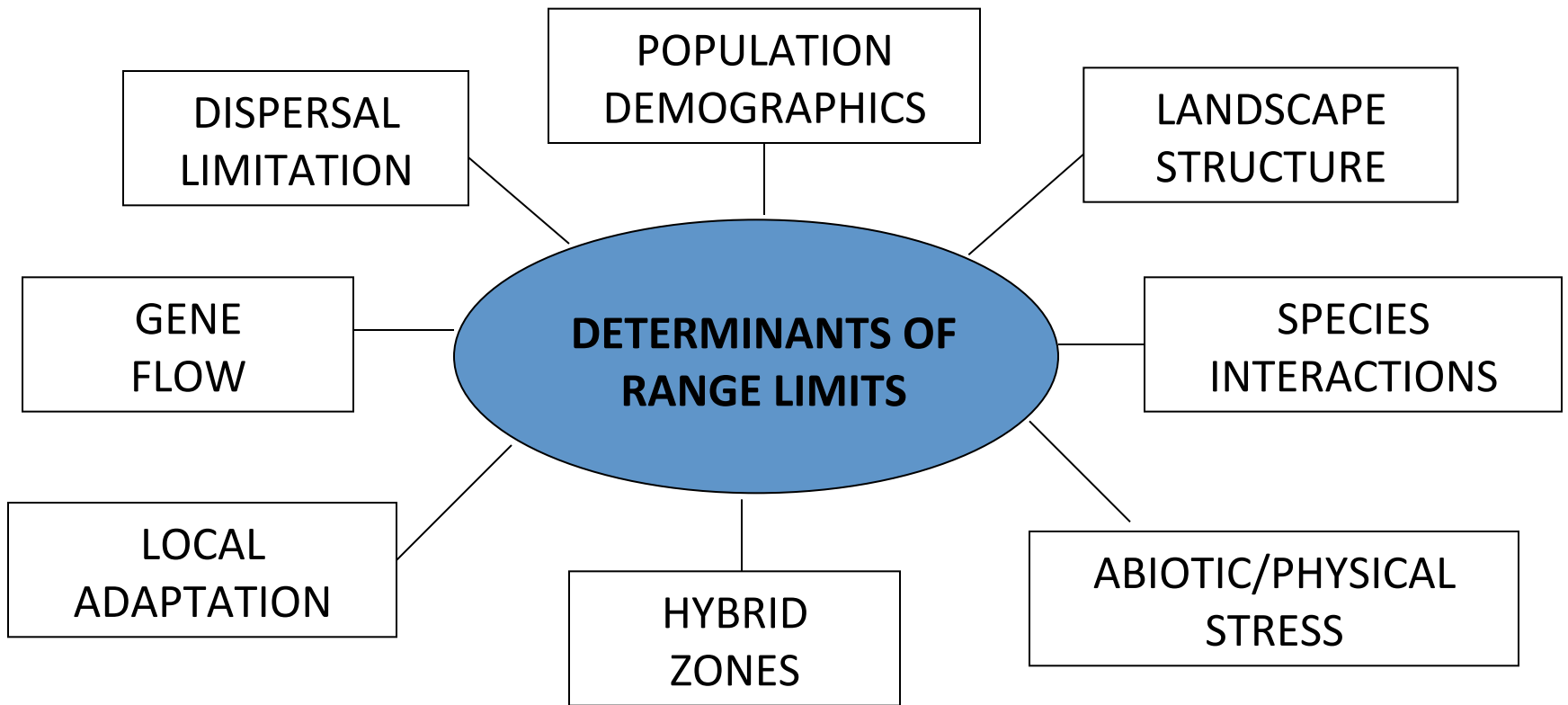

Predicting species responses to environmental change

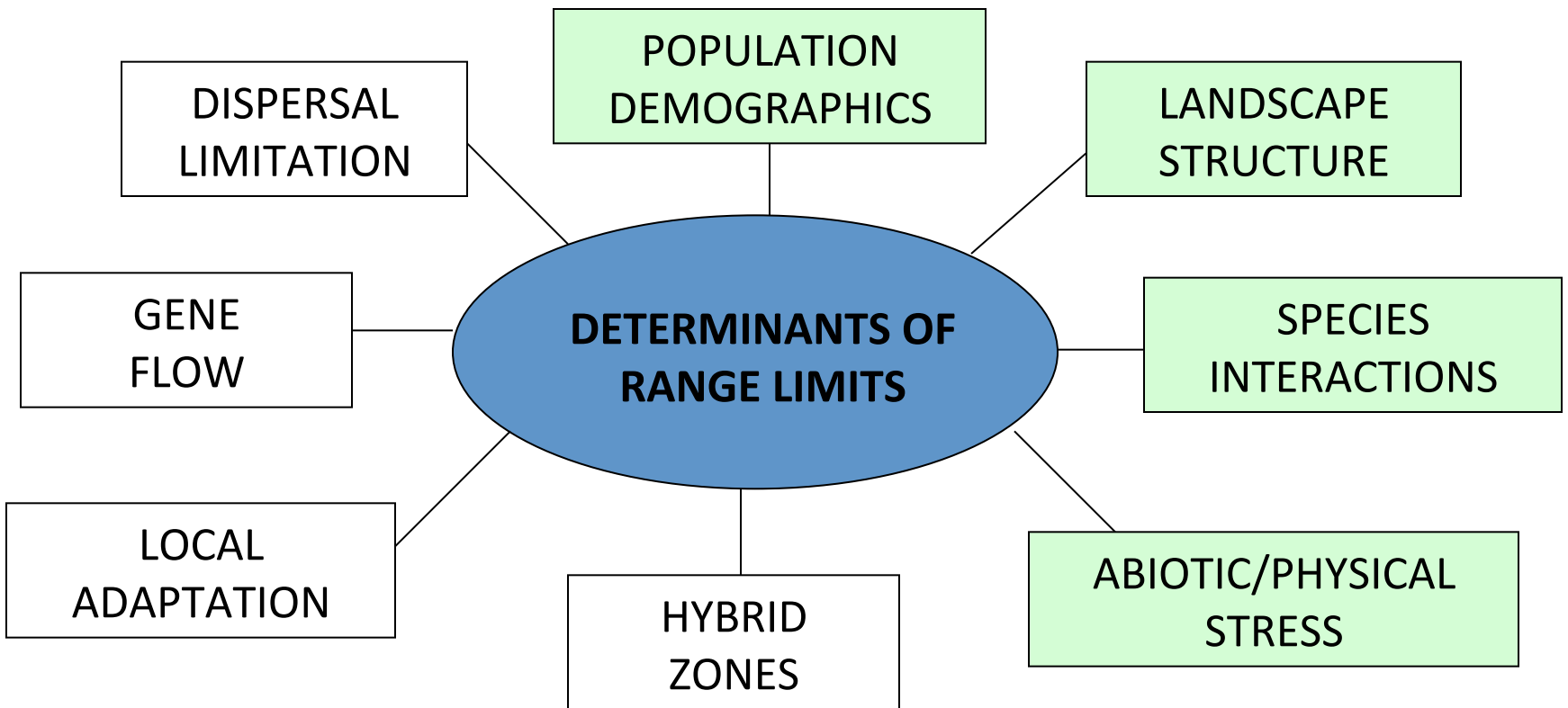

Predicting species responses to environmental change

Do processes acting on individual species apply to the general community?

How do communities change across space?

What environmental correlates are associated with species turnover?



Study System: Andean and Amazonian Birds

3300 species in
South America
(1/3 of global total)

2650 species in tropical
Andes and Amazonian
lowlands

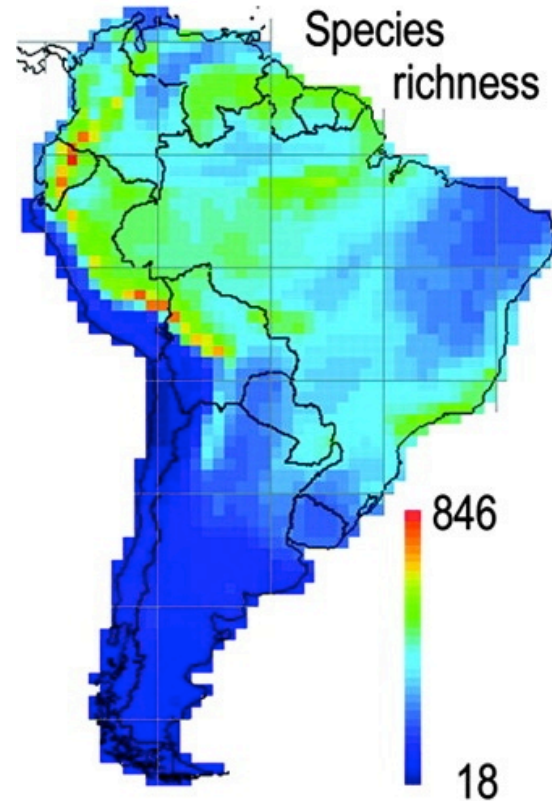

warm colors ~ higher richness

Bird species turnover highest in the Andes

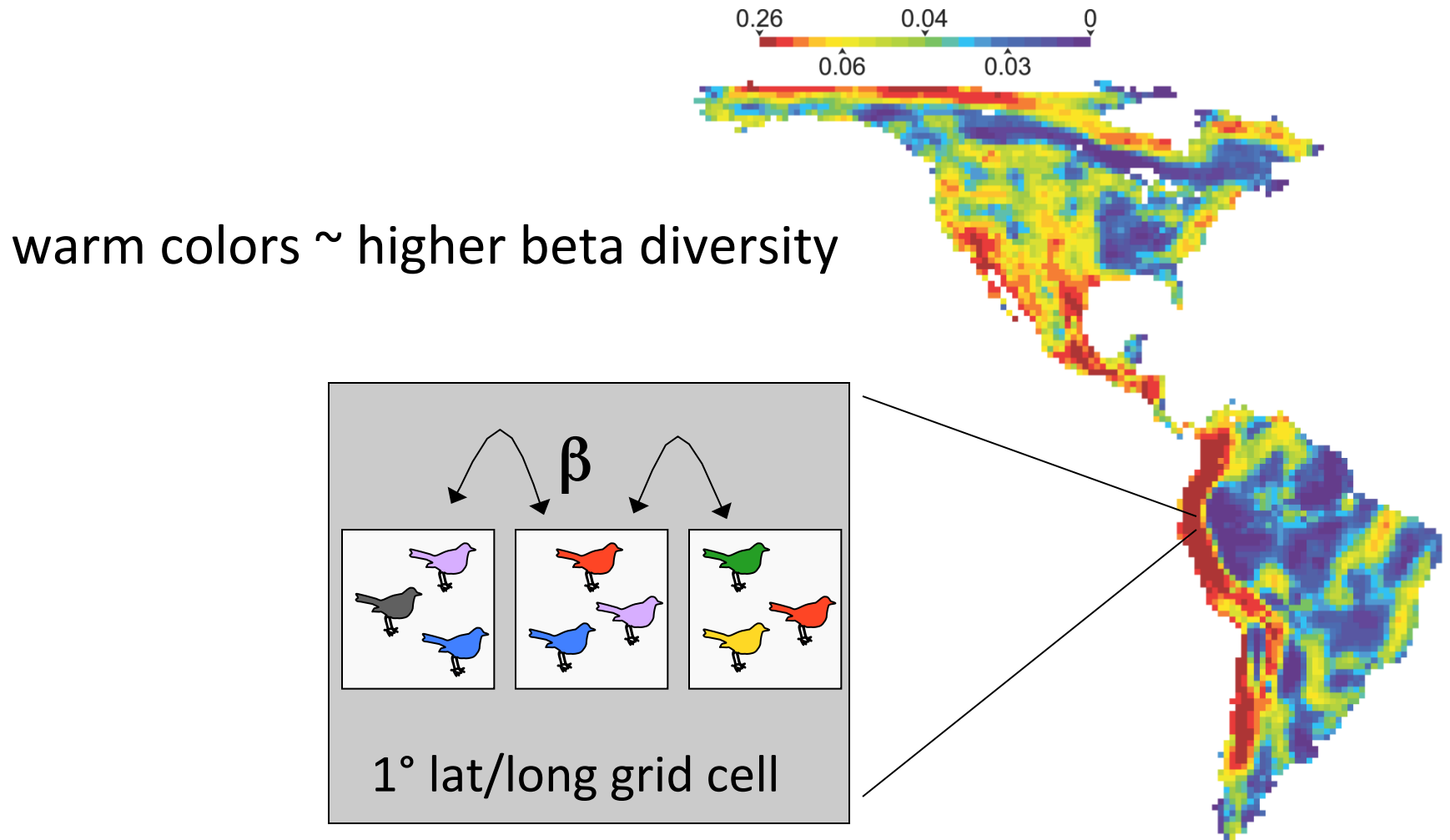

Expansive ranges of Amazonian birds

Hairy-crested Antbird

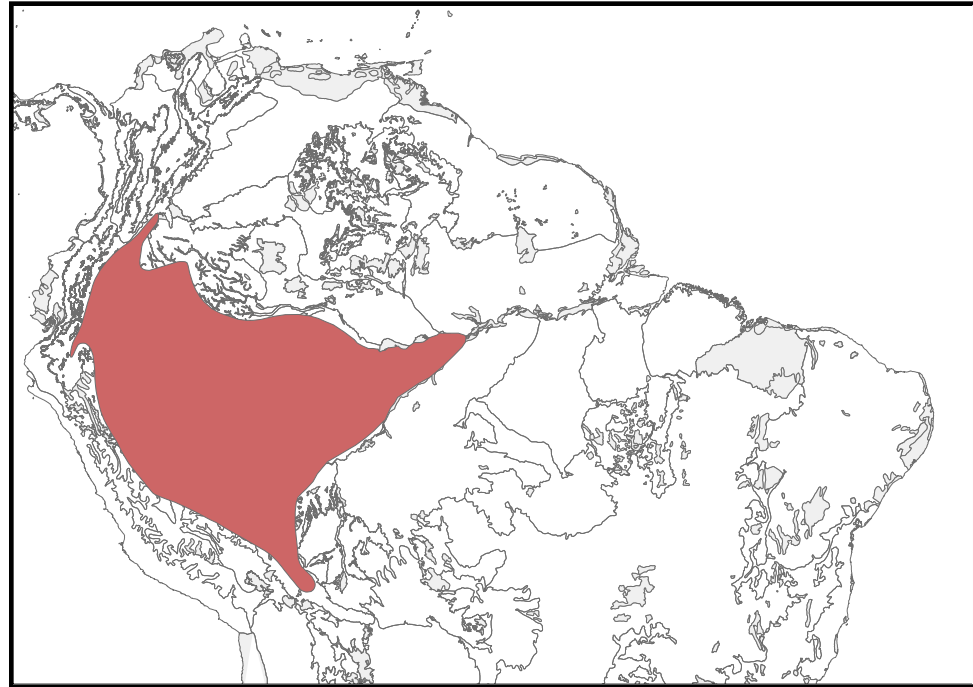

“Shoestring” distributions of montane birds

Blue-winged Mountain-Tanager

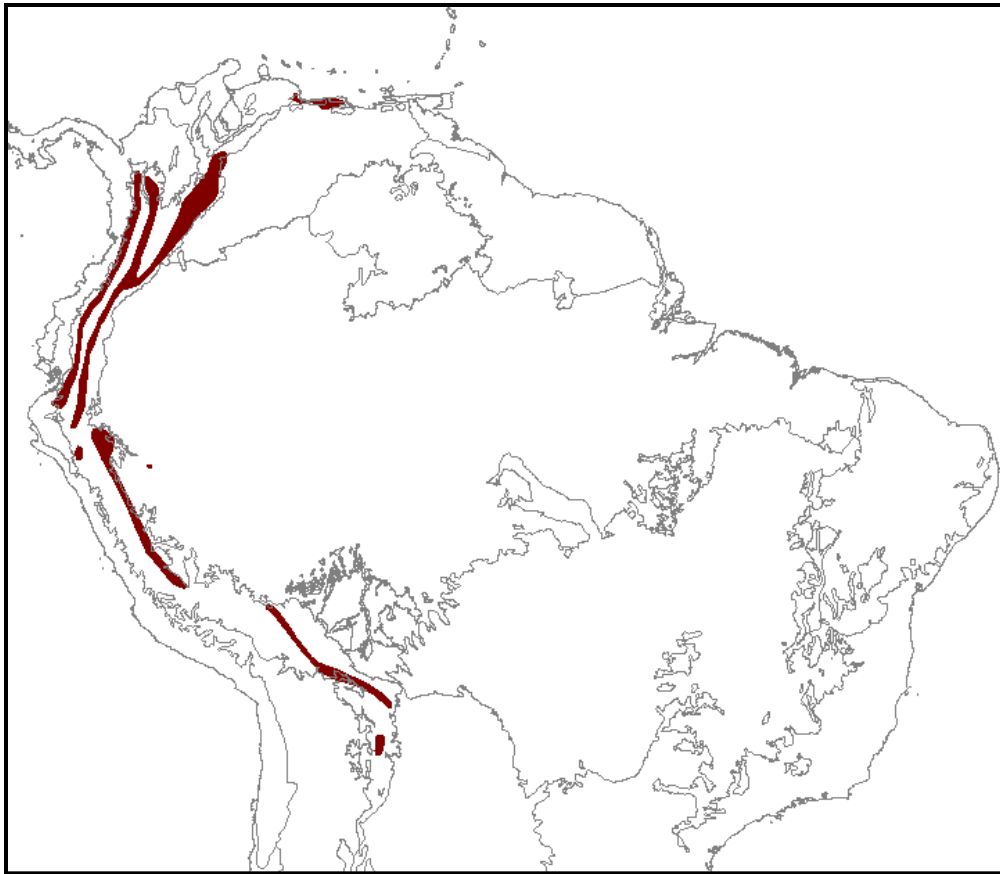

“Shoestring” distributions of montane birds

Long-tailed Antbird

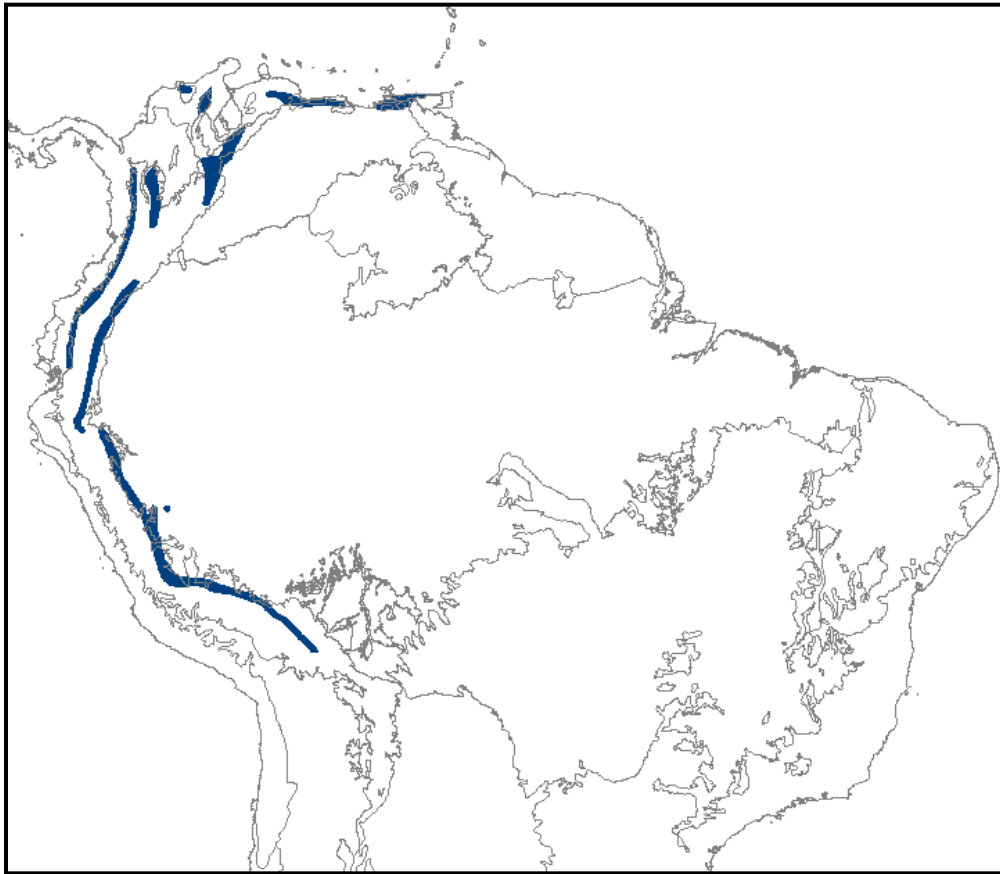

“Shoestring” distributions of montane birds

Deep-blue Flowerpiercer

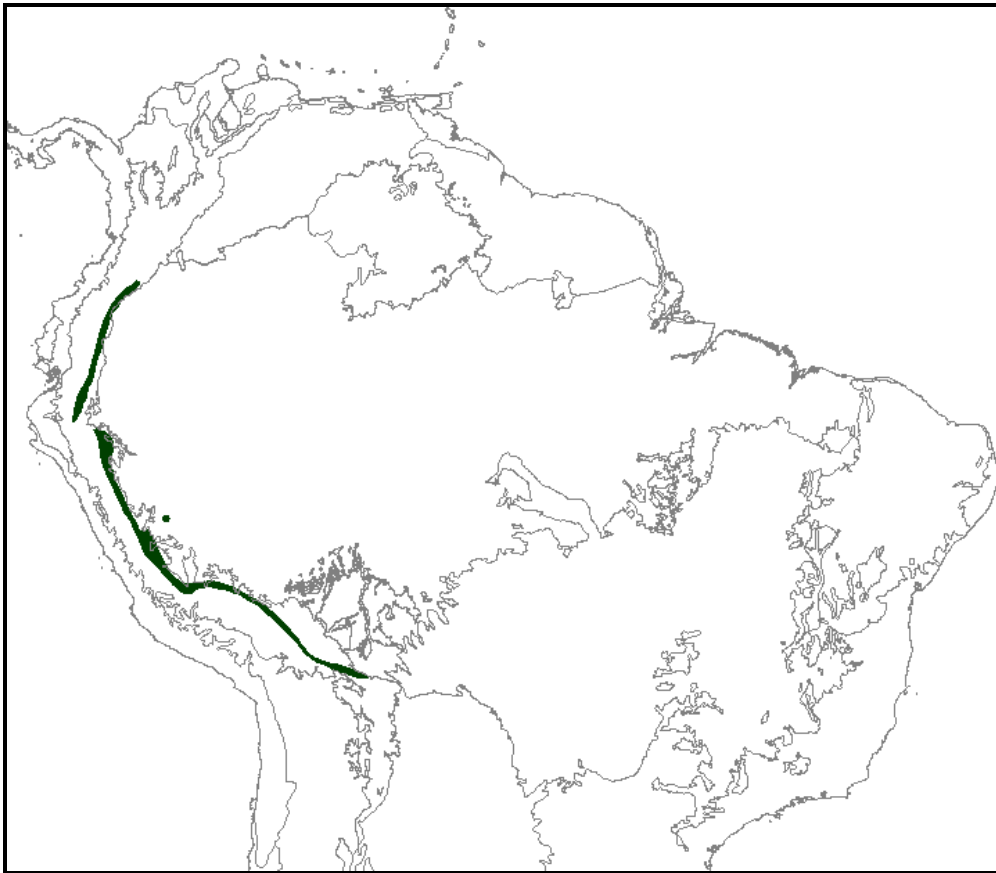

Tropical montane bird communities are characterized by high species richness and turnover

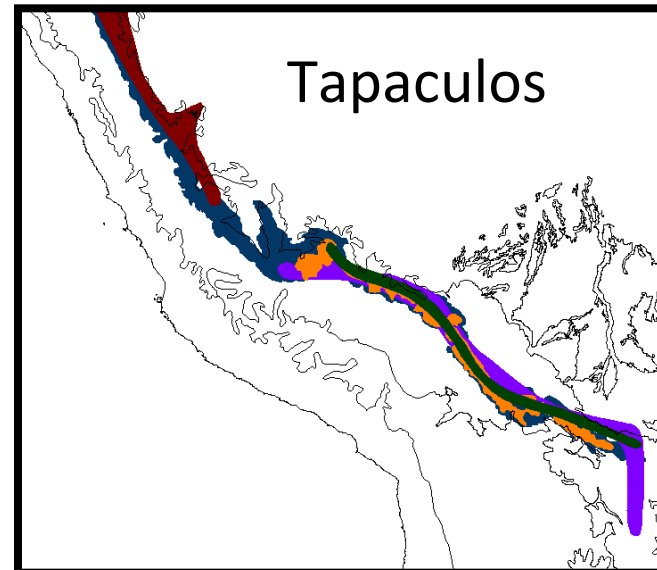
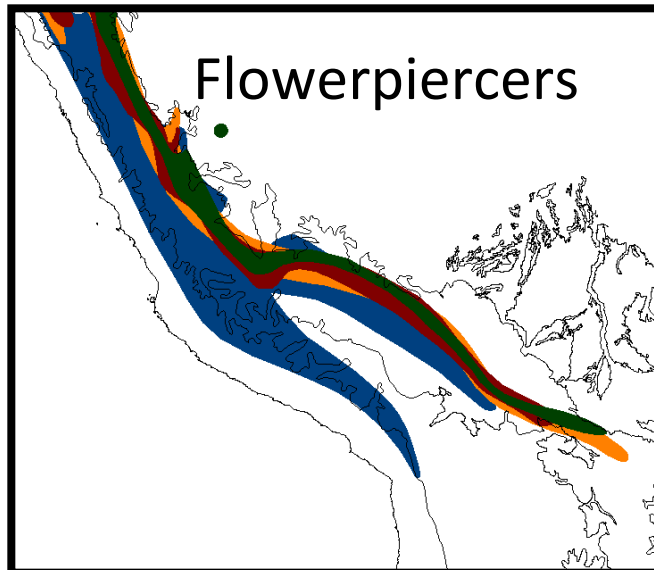
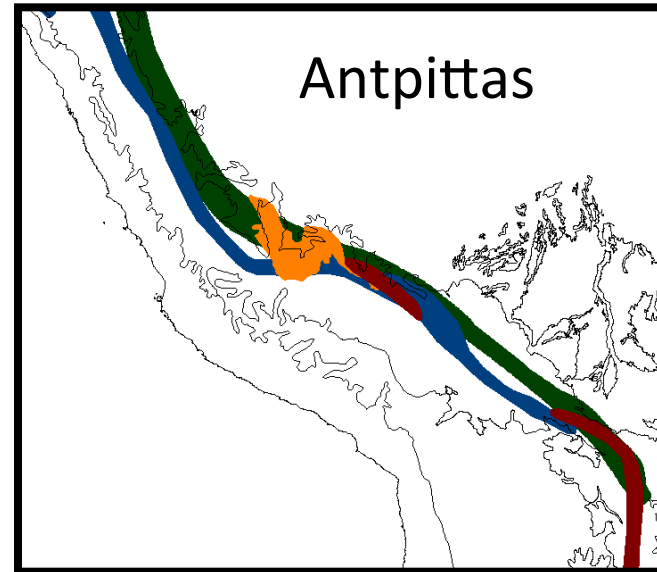
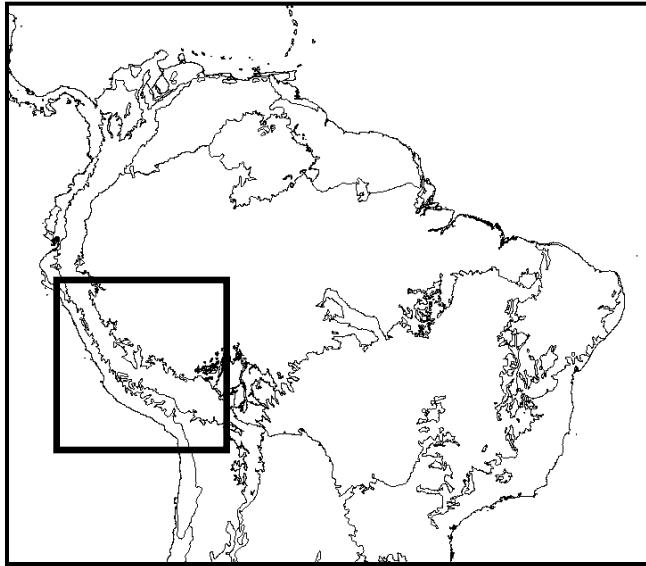

What maintains the range limits of bird species?

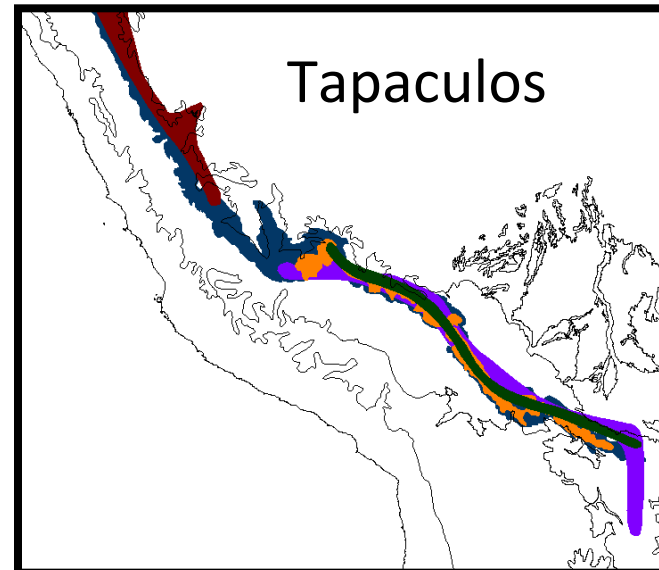
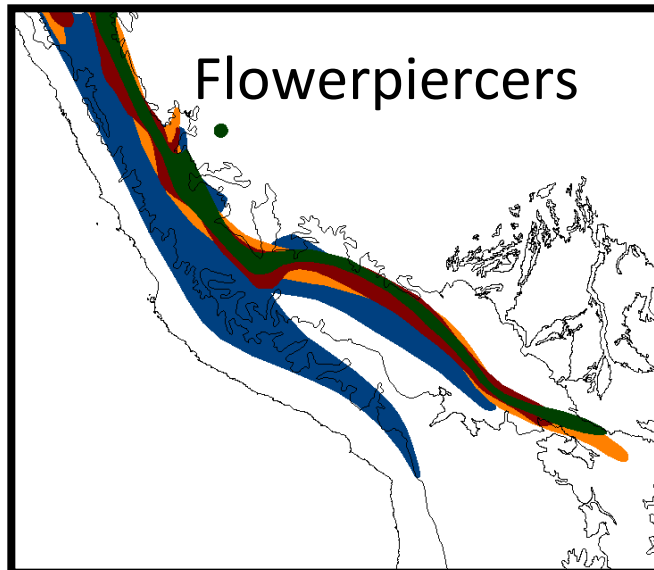
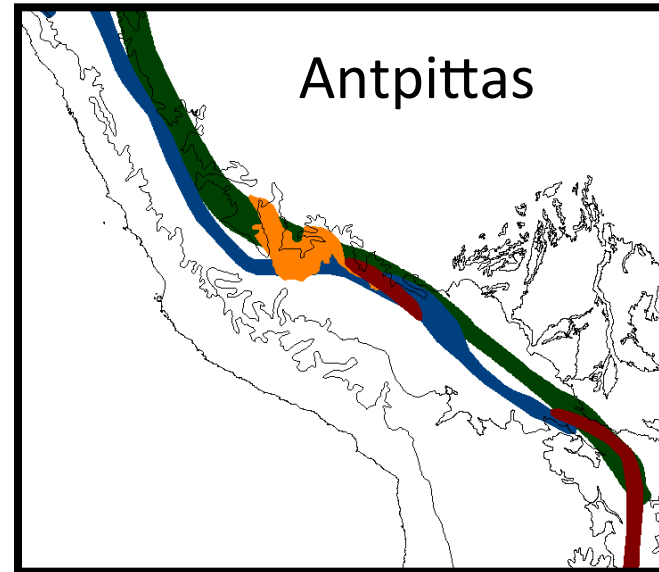
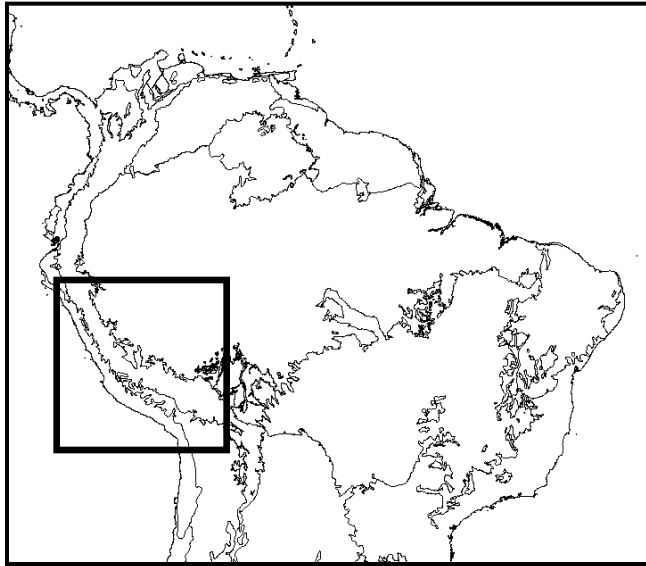

Relative importance of abiotic and biotic interactions

Environmental temperature

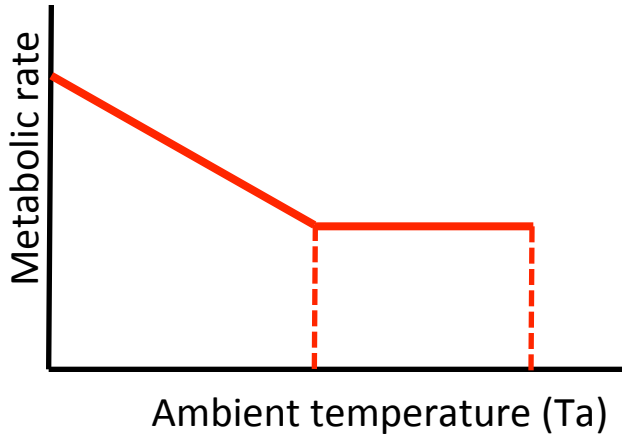

Competitive interactions

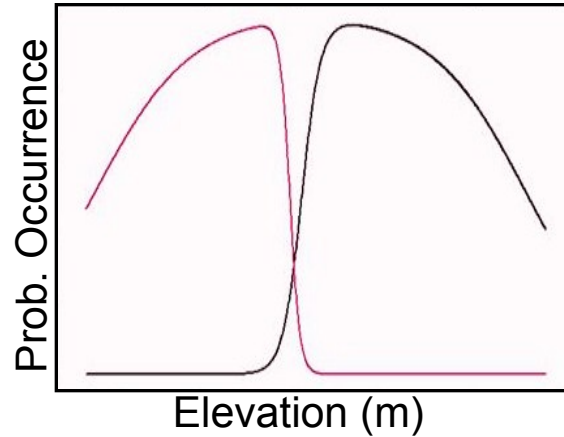

Nest predation



A little about me...

Grew up in Southern Indiana
called "Hoosiers"



Rolling hills of the
Ohio River Valley

A little about me...

Undergrad and Masters: Purdue University (1998-2004)

PhD: University of Florida (2004-2010)

Post-doc: UBC (2010-2012)

Assistant Professor since 2012



A little about me...

Favorite things...



Optional (but really great) reference for the course:

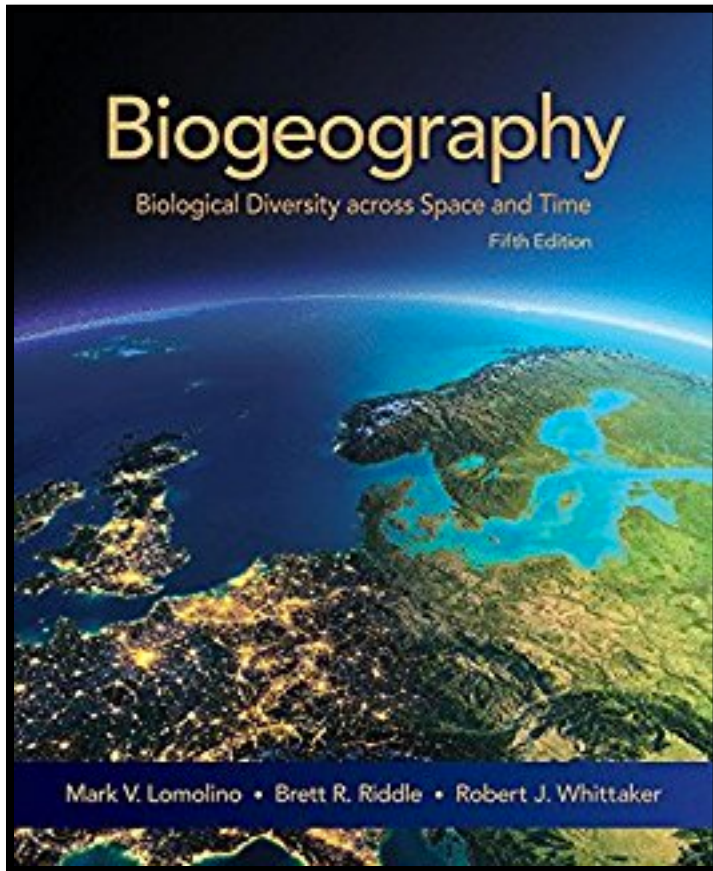

Biogeography: Biological diversity across space and time

Authors: Mark V. Lomolino, Brett R. Riddle, Robert J. Whittaker

Two copies on reserve at Woodward Library

I'll list chapters/pages relevant to each lecture...